



MVAPICH

MPI, PGAS and Hybrid MPI+PGAS Library

Designing Shared Address Space MPI libraries in the Many-core Era

[Jahanzeb Hashmi](#)

hashmi.29@osu.edu

Network Based Computing Laboratory (NBCL)

The Ohio State University

Outline

- Introduction and Motivation
- Background
 - Shared-memory Communication
 - Kernel-assisted Communication
- Shared Address-space (XPMEM) based Communication
 - Quantifying Performance Bottlenecks
 - Mitigating the Overheads with Proposed Designs
- Designing XPMEM based Reduction Collectives MPI_Allreduce / MPI_Reduce
- Performance Evaluation and Analysis
- Concluding Remarks

Parallel Programming Models Overview

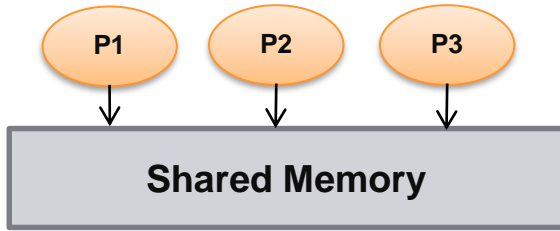

Shared Memory Model
SHMEM, DSM

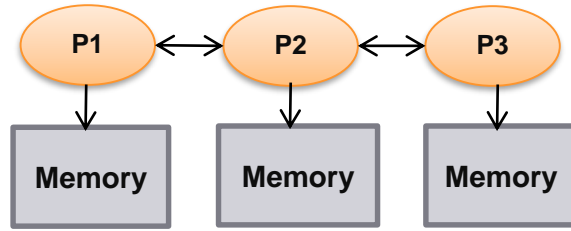

Distributed Memory Model
MPI (Message Passing Interface)

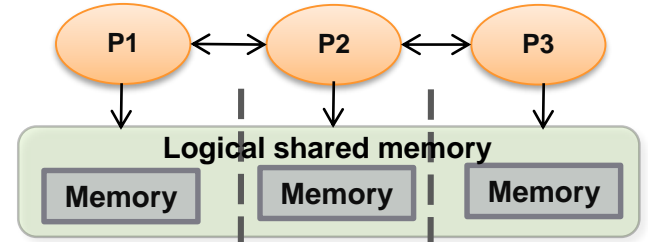

Partitioned Global Address Space (PGAS)
Global Arrays, UPC, Chapel, X10, CAF, ...

- Programming models provide abstract machine models
- Models can be mapped on different types of systems
 - e.g. Distributed Shared Memory (DSM), MPI within a node, etc.
- Programming models offer various communication primitives
 - Point-to-point (between pair of processes/threads)
 - Remote Memory Access (directly access memory of another process)
 - **Collectives (group communication)**

Diversity in HPC Architectures



	Knights Landing (KNL)	Xeon	OpenPower
Clock Speed	Low	High	Very High
Core count	High (64-72)	Low (8-16)	Low (8-12)
Hardware Threads	Medium (4)	Low (1-2)	High (8)
Multi-Socket	No	Yes	Yes
Max. DDR Channels	6	4	8
HBM/MCDRAM	Yes	No	No

Dense Nodes \Rightarrow More Intra Node Communication

Broad Challenges in MPI due to Architectural Diversity

- **Can we exploit high-concurrency and high-bandwidth offered by modern architectures?**
 - better resource utilization → high throughput → faster communication performance
 - Computation and communication offloading
- **Can we design “zero-copy” and contention-free MPI communication primitives?**
 - Memory copies are expensive on many-cores
 - “Zero-copy” (kernel-assisted) designs are Contention-prone

Intra-Node Communication in MPI

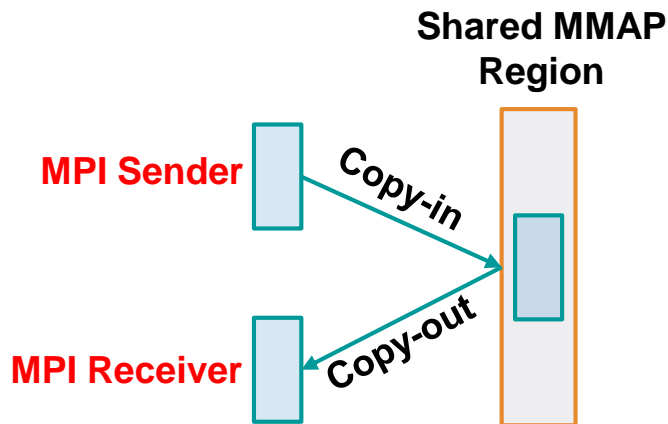

Shared Memory – SHMEM

Requires two copies
No system call overhead
Better for Small Messages

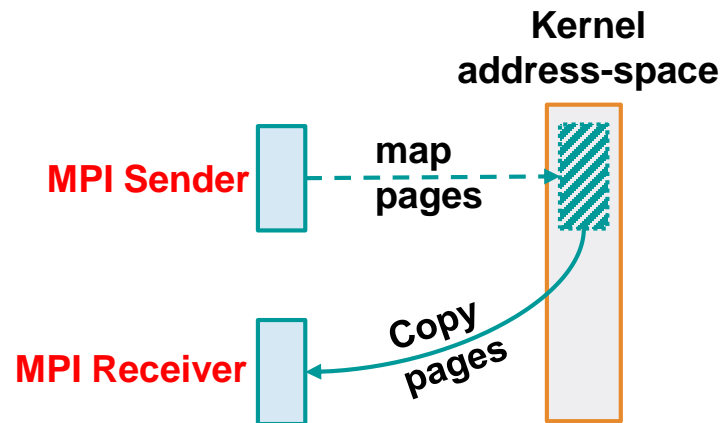

Kernel-Assisted Copy

System call overhead
Requires single(a.k.a “zero”) copy
Better for Large Messages

Outline

- Introduction and Motivation
- Background
 - Shared-memory Communication
 - Kernel-assisted Communication
- Shared Address-space (XPMEM) based Communication
 - Quantifying Performance Bottlenecks
 - Mitigating the Overheads with Proposed Designs
- Designing XPMEM based Reduction Collectives MPI_Allreduce / MPI_Reduce
- Performance Evaluation and Analysis
- Concluding Remarks

Shared Address-space based Communication

- XPMEM (<https://github.com/hjelmn/xpmem>) --- “Cross-partition Memory”
 - Mechanisms for a process to “*attach*” to the virtual memory segment of a remote process
 - Consists of a user-space API and a kernel module
- The sender process calls “`xpmem_make()`” to create a shared segment
 - Segment information is then shared with the receiver
- The receiver process calls “`xpmem_get()`” followed by “`xpmem_attach()`”
- The receiver process can directly read/write on the remote process’ memory

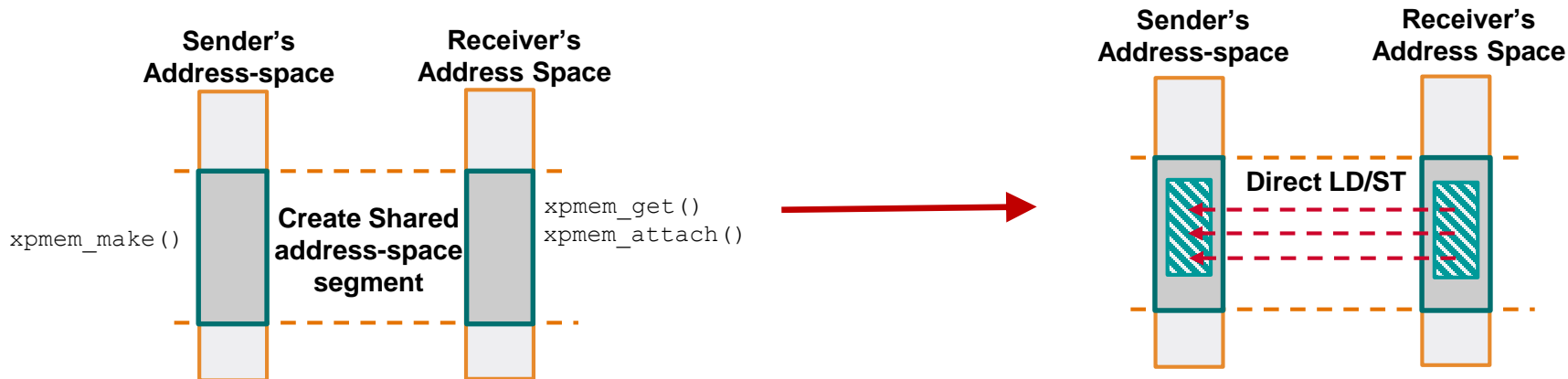

Quantifying the Registration Overheads of XPMEM

- XPMEM based one-to-all latency benchmark
 - Mimics rooted collectives
- A process needs to attach to remote process before memcpy
- Up to **65%** time spent in XPMEM registration for short message (4K)
- Increasing PPN increases the cost of `xpmem_get()` operation
 - Lock contention
 - Pronounced at small messages

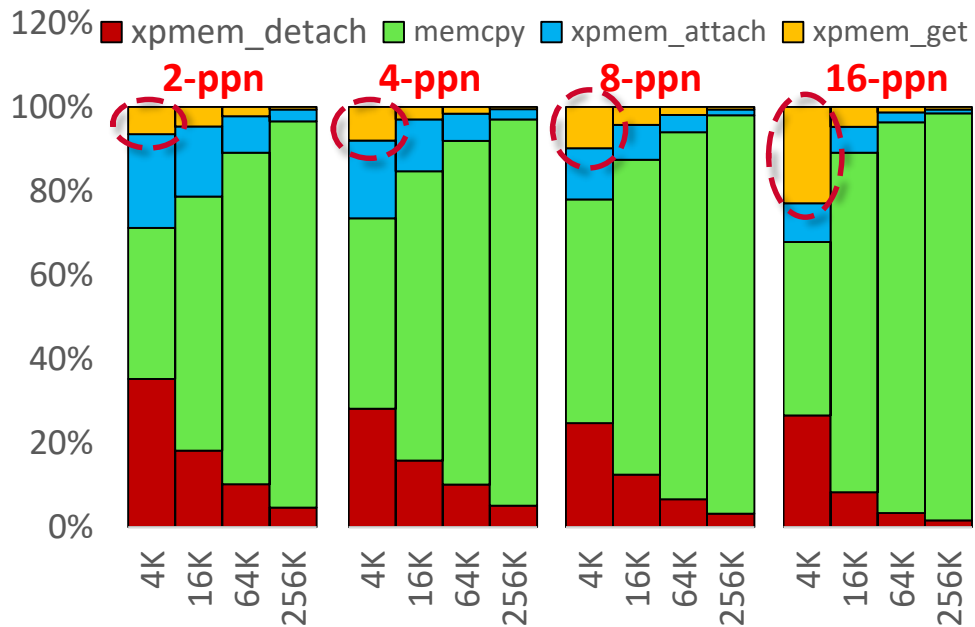

Relative costs of XPMEM API functions for different PPN using one-to-all communication benchmark on a single dual-socket Broadwell node with 14 cores.

How can we alleviate the overheads posed by XPMEM registration and improve the performance of shared address-space based communication primitives?



Registration Cache!

Challenges and Contribution Summary

- XPMEM remote registration is costly
- Kernel-assisted zero-copy communication cause contention with increasing concurrency.
- Lack of true zero-copy reductions in MPI
- Efficient shared address-space based MPI point-to-point communication
- Contention-free MPI collectives
- Truly zero-copy MPI reduction collectives

Registration Cache for XPMEM based Communication

- Remote pages that are *attached* are kept in an AVL tree
 - One tree per remote peer
 - Insertion and lookup in $O(\log n)$ time
- First miss, attach remote VMA and cache locally
 - Later accesses are found in registration cache
- Lazy memory deregistration principle
 - Deregister pages only at *finalize* or when capacity-miss occurs (FIFO)
- MPI operations using same buffer do not incur XPMEM registration overheads
 - Performance is only limited by the memcopy

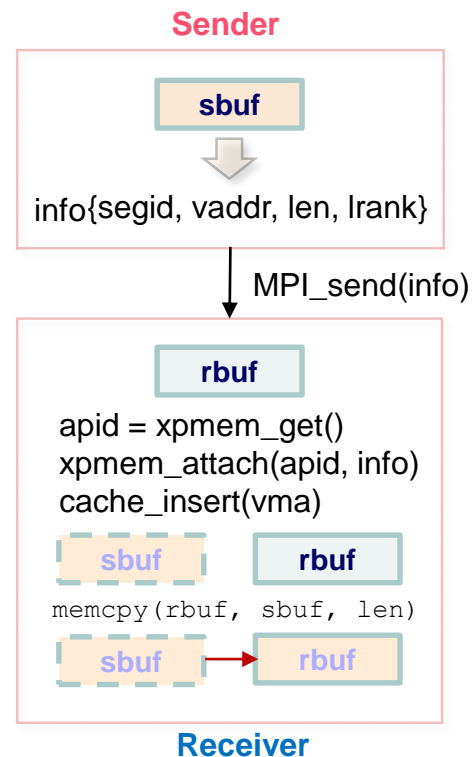

Impact of Registration Cache on the Performance of XPMEM based Communication

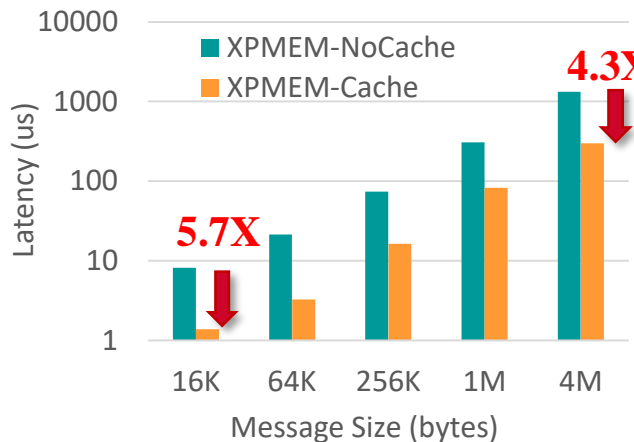

Two-process latency at varying messages

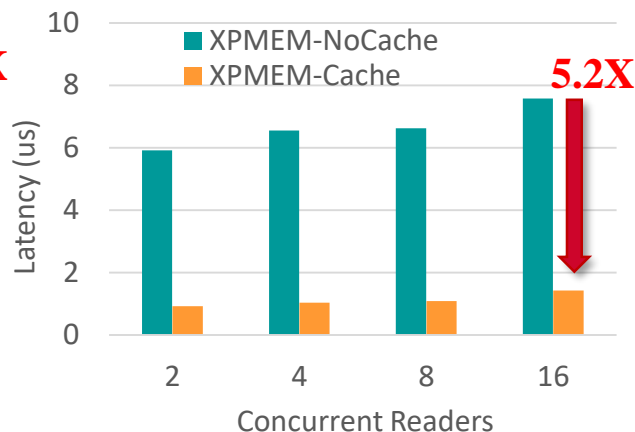

Multi-process latency at 16KB message

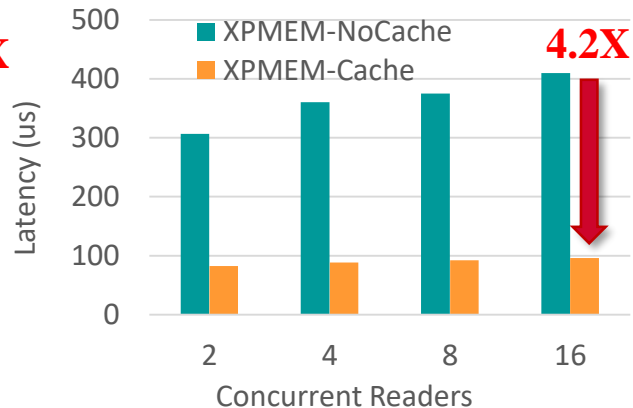

Multi-process latency at 1MB message

- Registration cache mitigates the overhead of XPMEM registration of remote memory segments
 - At first miss, remote pages are attached and cached
- Look-up in registration cache cost $O(\log n)$ time due to AVL tree based design
- Benefits are more pronounced at small to medium message size

Performance of XPMEM and CMA based Communication

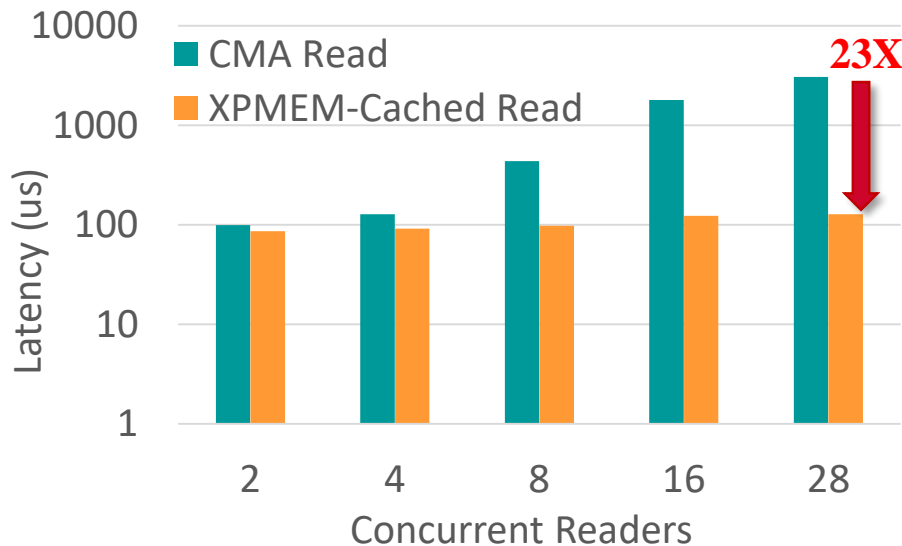

Broadwell (2-socket, 14-core)

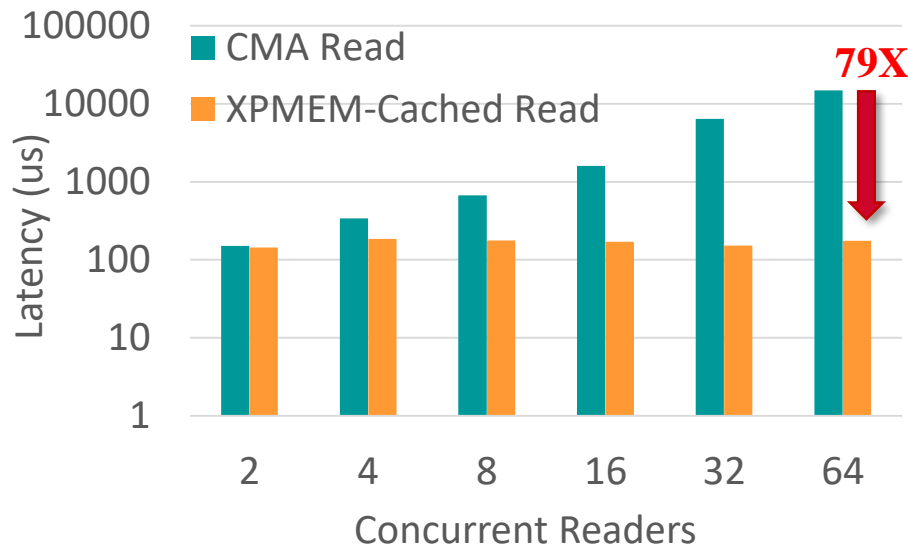

KNL (68-core, cache-mode)

- Latency comparison of CMA and XPMEM based “read” on a pair-wise *one-to-all* communication pattern at 1MB message size
- CMA based reads suffer from **process-level lock-contention** inside the kernel
- XPMEM based reads do not have locking overheads and thus show significantly scalable performance

Outline

- Introduction and Motivation
- Background
 - Shared-memory Communication
 - Kernel-assisted Communication
- Shared Address-space (XPMEM) based Communication
 - Quantifying Performance Bottlenecks
 - Mitigating the Overheads with Proposed Designs
- **Designing XPMEM based Reduction Collectives MPI_Allreduce / MPI_Reduce**
- Performance Evaluation and Analysis
- Concluding Remarks

Current Designs for MPI Collectives

- Send/Recv based collectives
 - Rely on the implementation of MPI point-to-point primitives
 - Handshake overheads for each rendezvous message transfer
- Direct Shared-memory based MPI collectives
 - Communication between pairs of processes realized by copying message to a shared-memory region (**copy-in / copy-out**)
- Direct Kernel-assisted MPI collective e.g., CMA, LiMIC, KNEM
 - Can perform direct “*read*” or “*write*” on the user buffers (**zero-copy**)
 - Performance relies on the communication pattern of the collective
- Use two-level designs for inter-node

Towards Truly Zero-copy Reductions

- Existing work on direct collectives that are based on CMA, LiMIC, KNEM, do not offer zero-copy for reduction implementations
 - Remote data is required to be copied to local memory first
 - Extra copies detrimental to collectives performance
- Can we design “zero-copy” reduction collectives using shared address-space paradigm?
 - Shared address-space based MPI_Allreduce and MPI_Reduce designs for MPI
 - Multi-leader design for inter-node scaling

Shared Address-space (XPMEM-based) Reduction Collectives

- Offload reduction computation and communication to peer MPI ranks
 - Every Peer has direct “load/store” access to other peer’s buffers
 - Multiple leader ranks independently carry-out reductions for intra-and inter-node phases in parallel
 - All peers remain busy and exploit high concurrency of the architecture
- True “zero-copy” design for Allreduce and Reduce
 - No copies require during the entire duration of Reduction operation
 - Scalable to multiple nodes via multi-leader schemes
- No contention overheads due to proposed registration cache design
 - memory copies happen in “user-space”

Shared Address-space based MPI_Allreduce

- Every process in the communicator exchanges sendbuf / recvbuf memory segment Information with other processes
 - Application buffers are registered with XPMEM and cached in Registration Cache
- XPMEM based MPI_Allreduce
 - Step-1: Parallel Intra-node Partitioned *Reduce*
 - Step-2: Parallel Inter-node Partitioned *Allreduce*
 - Step-3: Parallel Intra-node Partitioned *Bcast*
- Similar approach for MPI_Reduce as well with minor differences
 - Final Bcast step of Allreduce is not performed
 - Final Results needs to be delivered to the “root” process
 - Use one extra point-to-point Send / Recv if “root” is arbitrary

Outline

- Introduction and Motivation
- Background
 - Shared-memory Communication
 - Kernel-assisted Communication
- Shared Address-space (XPMEM) based Communication
 - Quantifying Performance Bottlenecks
 - Mitigating the Overheads with Proposed Designs
- Designing XPMEM based Reduction Collectives MPI_Allreduce / MPI_Reduce
- **Performance Evaluation and Analysis**
- **Concluding Remarks**

Evaluation Methodology and Cluster Testbeds

Hardware Specification of Cluster Testbeds

Specification	Xeon	Xeon Phi	OpenPOWER
Processor Family	Intel Broadwell	Knights Landing	IBM POWER-8
Processor Model	E5 2680v4	KNL 7250	PPC64LE
Clock Speed	2.4 GHz	1.4 GHz	3.4 GHz
No. of Sockets	2	1	2
Cores Per Socket	14	68	10
Threads Per Core	1	4	8
RAM (DDR)	128 GB	96 GB	256 GB
Interconnect	IB-EDR (100G)	IB-EDR (100G)	IB-EDR (100G)

- Proposed designs, implemented on MVAPICH2, is called MVPIACH2-XPMEM
- Compared against default MVPAPICH2-2.3, Intel MPI 2017, OpenMPI v3.0.0, Spectrum MPI v10.1.0.2
- OSU Microbenchmarks, MiniAMR kernel, and AlexNet DNN Training using CNTK

Overview of the MVAPICH2 Project

- High Performance open-source MPI Library for InfiniBand, Omni-Path, Ethernet/iWARP, and RDMA over Converged Ethernet (RoCE)
 - MVAPICH (MPI-1), MVAPICH2 (MPI-2.2 and MPI-3.1), Started in 2001, First version available in 2002
 - MVAPICH2-X (MPI + PGAS), Available since 2011
 - Support for GPGPUs (MVAPICH2-GDR) and MIC (MVAPICH2-MIC), Available since 2014
 - Support for Virtualization (MVAPICH2-Virt), Available since 2015
 - Support for Energy-Awareness (MVAPICH2-EA), Available since 2015
 - Support for InfiniBand Network Analysis and Monitoring (OSU INAM) since 2015
 - **Used by more than 2900 organizations in 86 countries**
 - **More than 469,000 (> 0.46 million) downloads from the OSU site directly**
 - Empowering many TOP500 clusters (Nov '17 ranking)
 - **1st, 10,649,600-core (Sunway TaihuLight) at National Supercomputing Center in Wuxi, China**
 - 9th, 556,104 cores (Oakforest-PACS) in Japan
 - 12th, 368,928-core (Stampede2) at TACC
 - 17th, 241,108-core (Pleiades) at NASA
 - 48th, 76,032-core (Tsubame 2.5) at Tokyo Institute of Technology
 - Available with software stacks of many vendors and Linux Distros (RedHat and SuSE)
 - <http://mvapich.cse.ohio-state.edu>
- Empowering Top500 systems for over a decade



Micro-benchmark Evaluation on Broadwell Cluster

OSU_Allreduce

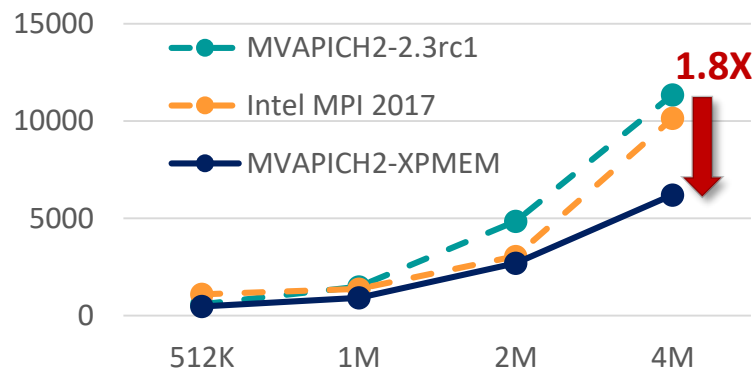
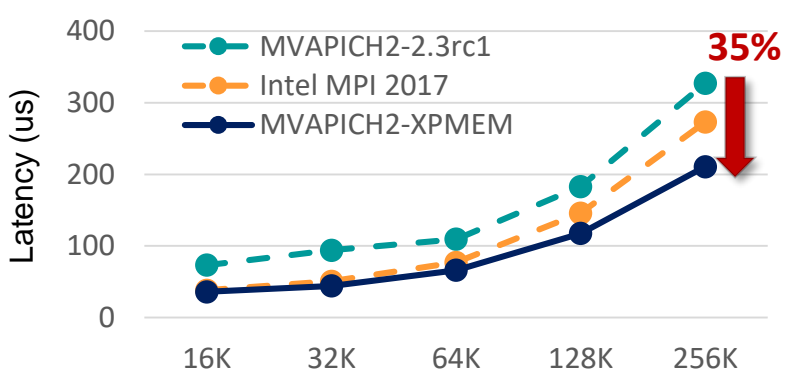

OSU_Reduce

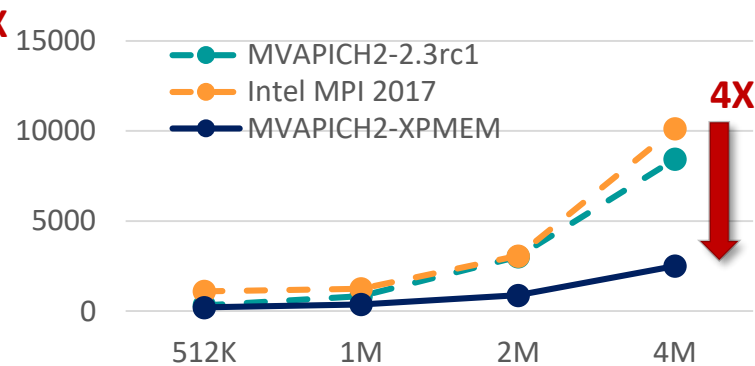
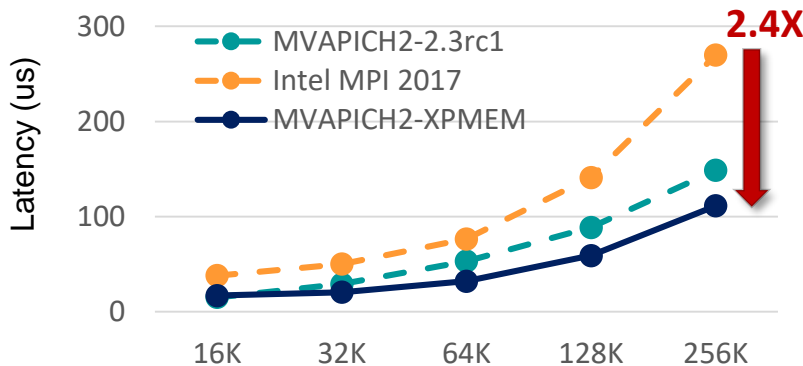

- 16 nodes, 256 processes of dual-socket Broadwell system
- Up to **1.8X** improvement for 4MB AllReduce and **4X** improvement for 4MB Reduce

Micro-benchmark Evaluation on KNL Cluster

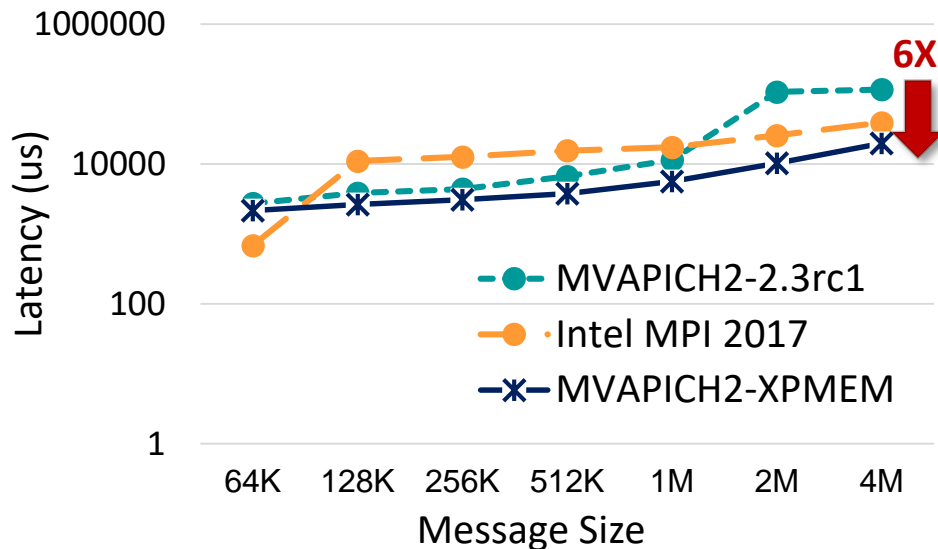

OSU_Allreduce (KNL 256 procs)

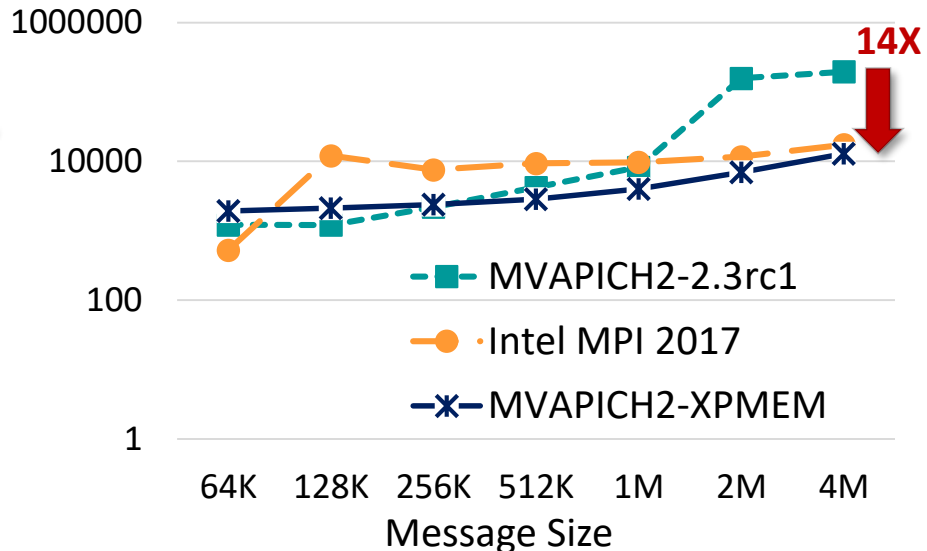

OSU_Reduce (KNL 256 procs)

- 4 x KNL 7250 in cache-mode with XPMEM based reduction collectives
- **6X and 14X** improvement over Intel MPI 2017 on XPMEM based Allreduce and Reduce respectively, on 4MB message size

Micro-benchmark Evaluation on OpenPOWER Cluster

OSU_Allreduce

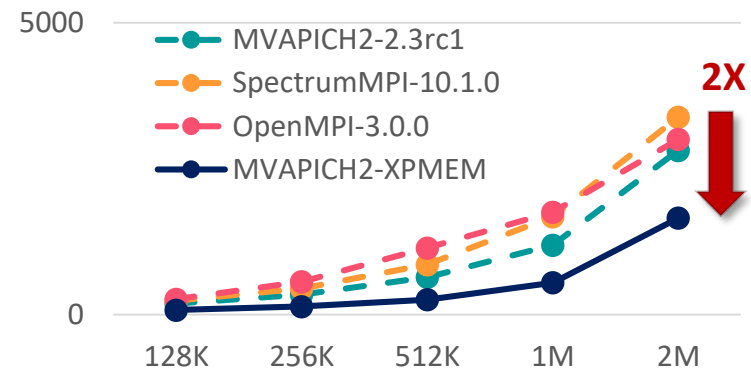
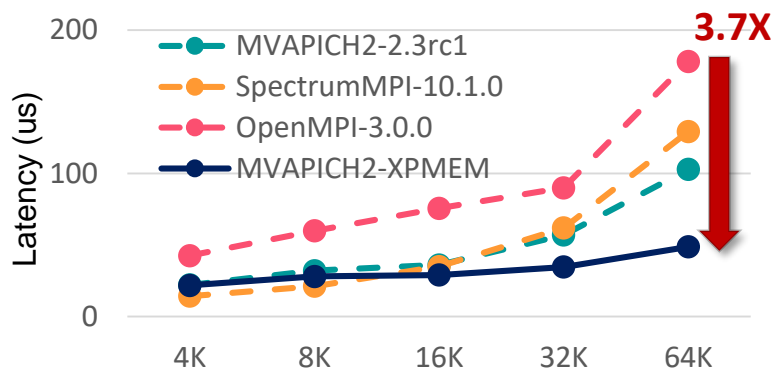

OSU_Reduce

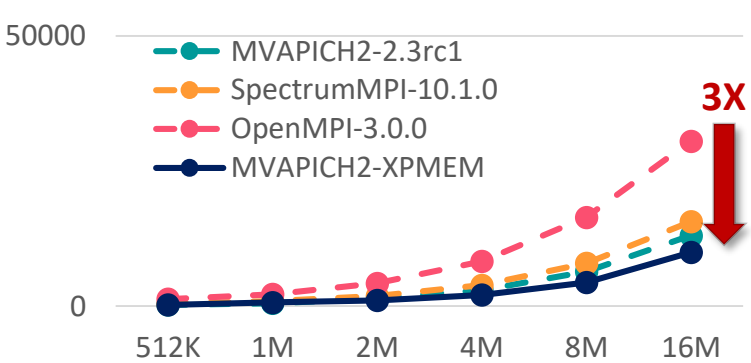
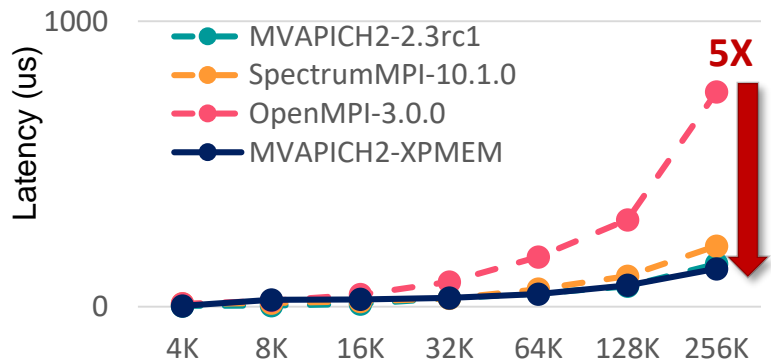

- Two POWER8 dual-socket nodes each with 20 ppn
- Up to **2X** improvement for Allreduce and **3X** improvement for Reduce at 4MB message

Application Performance of MPI_Allreduce on Broadwell

CNTK AlexNet Training
(B.S=default, iteration=50, ppn=28)

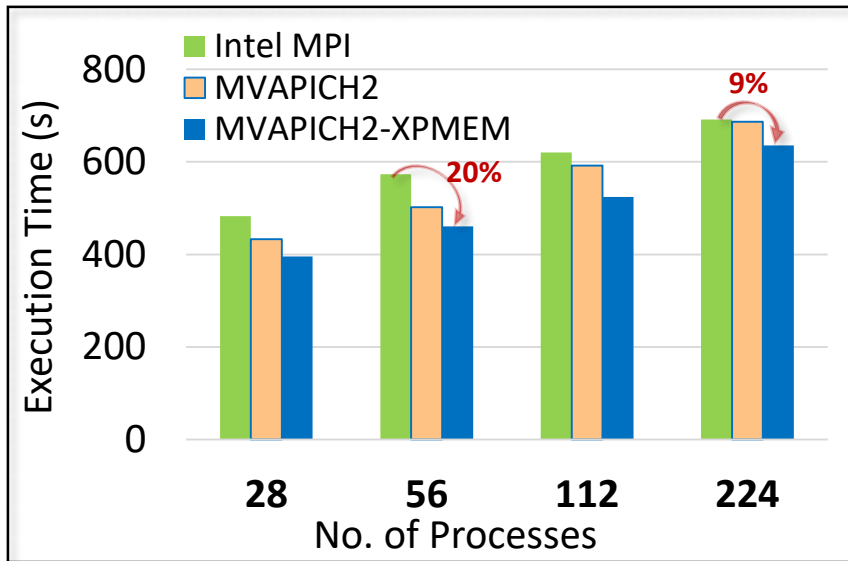

MiniAMR (dual-socket, ppn=16)

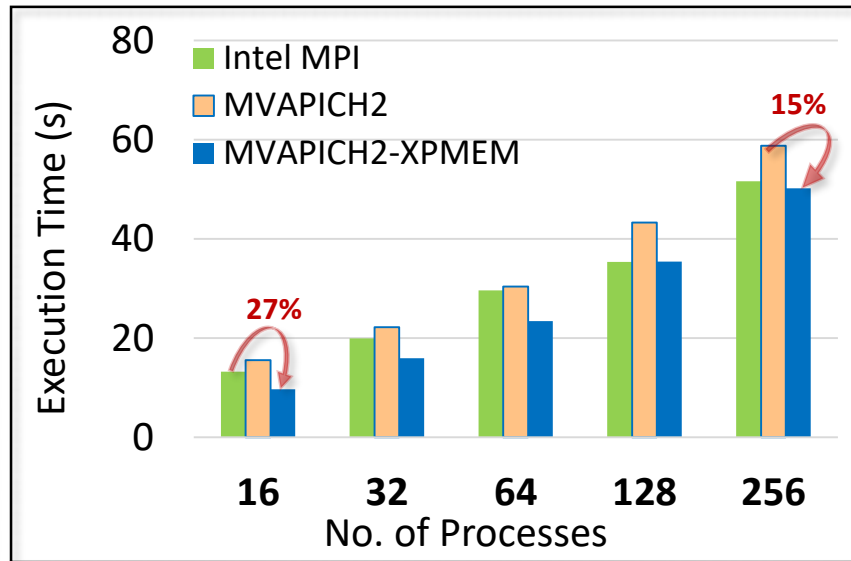

- Up to **20%** benefits over IMPI for CNTK DNN training using AllReduce
- Up to **27%** benefits over IMPI and up to **15%** improvement over MVAPICH2 for MiniAMR application kernel

miniAMR using XPMEM-based AllReduce on OpenPOWER Cluster

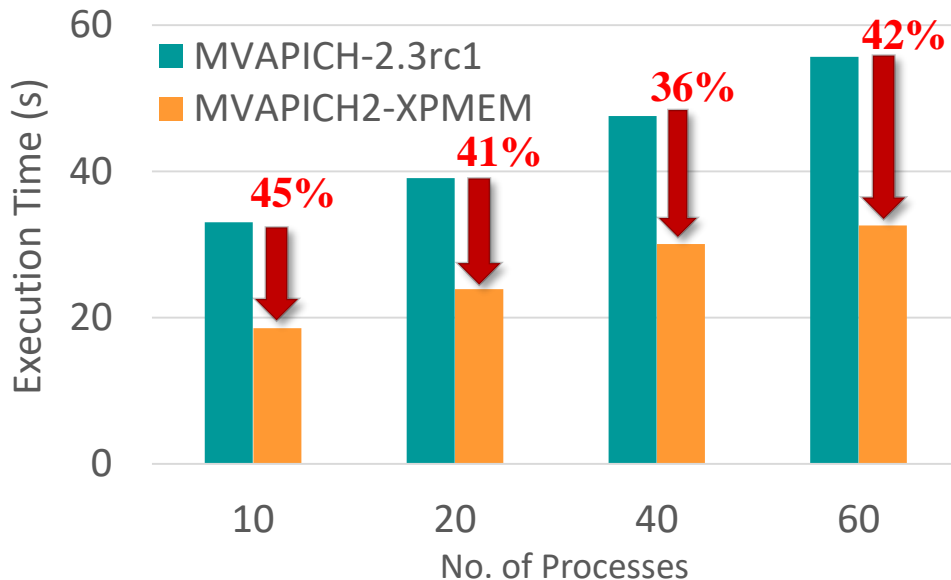

OpenPOWER (weak-scaling, 3 nodes, ppn=20)

- miniAMR application execution time comparing MVAPICH2-2.3rc1 and optimized All-Reduce design
 - MiniAMR application for weak-scaling workload on up to three POWER8 nodes.

Outline

- Introduction and Motivation
- Background
 - Shared-memory Communication
 - Kernel-assisted Communication
- Shared Address-space (XPMEM) based Communication
 - Quantifying Performance Bottlenecks
 - Mitigating the Overheads with Proposed Designs
- Designing XPMEM based Reduction Collectives MPI_Allreduce / MPI_Reduce
- Performance Evaluation and Analysis
- **Concluding Remarks**

Concluding Remarks

- Characterized the performance trade-offs involved in designing Shared address-space based communication in MPI
 - Registration cache based schemes to overcome performance bottlenecks
- Design and Implementation of “*true zero-copy*” reduction collectives in MPI
 - Demonstrated the performance benefits of new MPI_Allreduce and MPI_Reduce designs on Xeon, Xeon Phi, and OpenPOWER architecture
- Demonstrated the efficacy of the proposed solutions at micro-benchmarks as well as wide range of applications
 - AMR kernel, Neural Network Training, micro-benchmark
 - Significant speedup over existing designs in prevalent MPI libraries such as MVPAICH2, OpenMPI, IntelMPI, and SpectrumMPI
- We plan to expand to designs to other collectives and evaluate other architectures e.g., ARM

Thank You!

hashmi.29@osu.edu

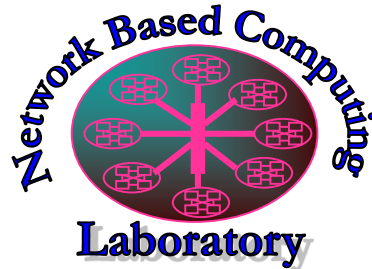

Network-Based Computing Laboratory

<http://nowlab.cse.ohio-state.edu/>



The High-Performance MPI/PGAS Project
<http://mvapich.cse.ohio-state.edu/>



High-Performance
Big Data

The High-Performance Big Data Project
<http://hibd.cse.ohio-state.edu/>



The High-Performance Deep Learning Project
<http://hidl.cse.ohio-state.edu/>